

Planta Baixa

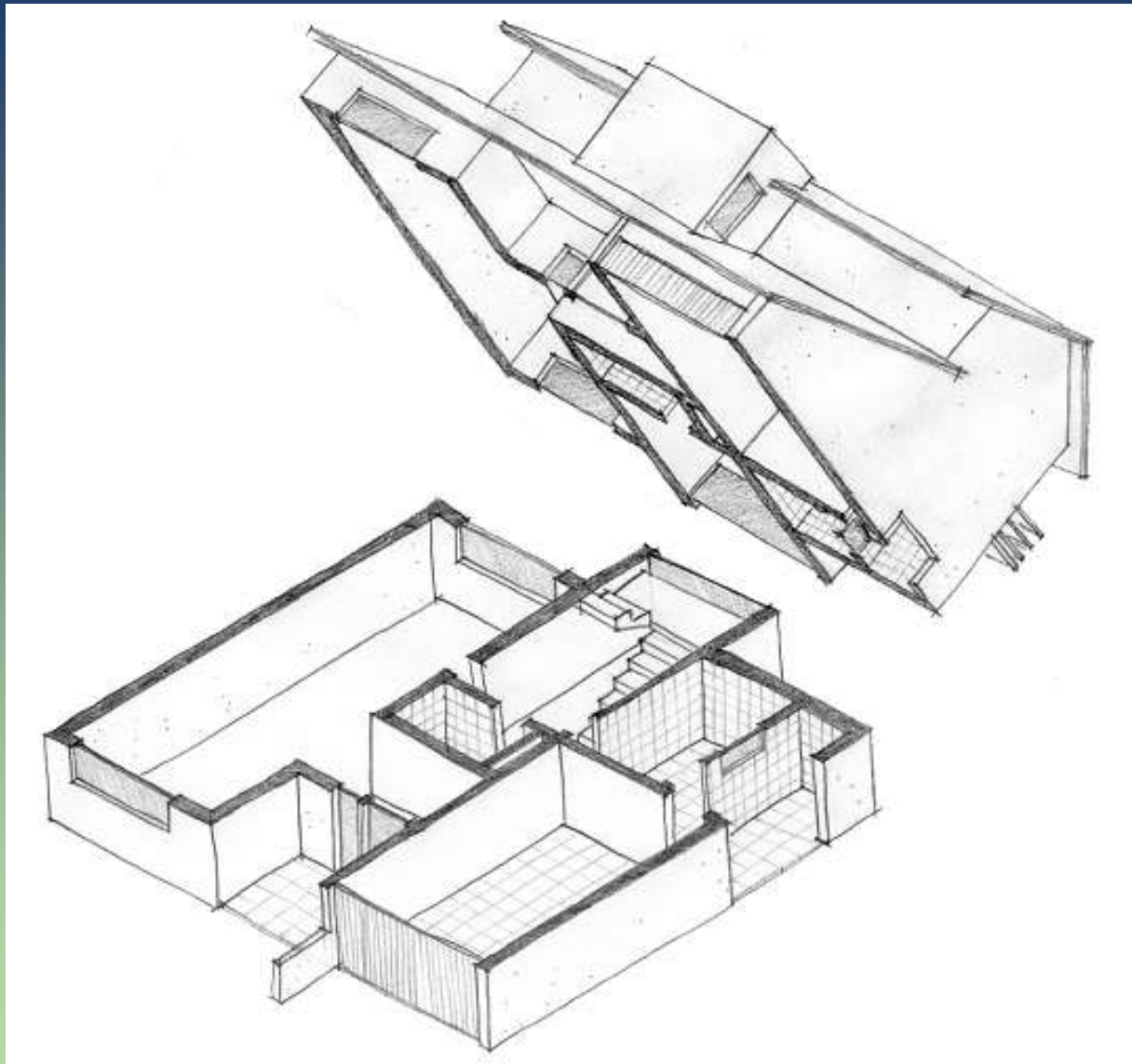

Aula 01

Desenho Arquitetônico



Planta Baixa – Técnica

Planta Baixa - Humanizada



Planta baixa - Técnica

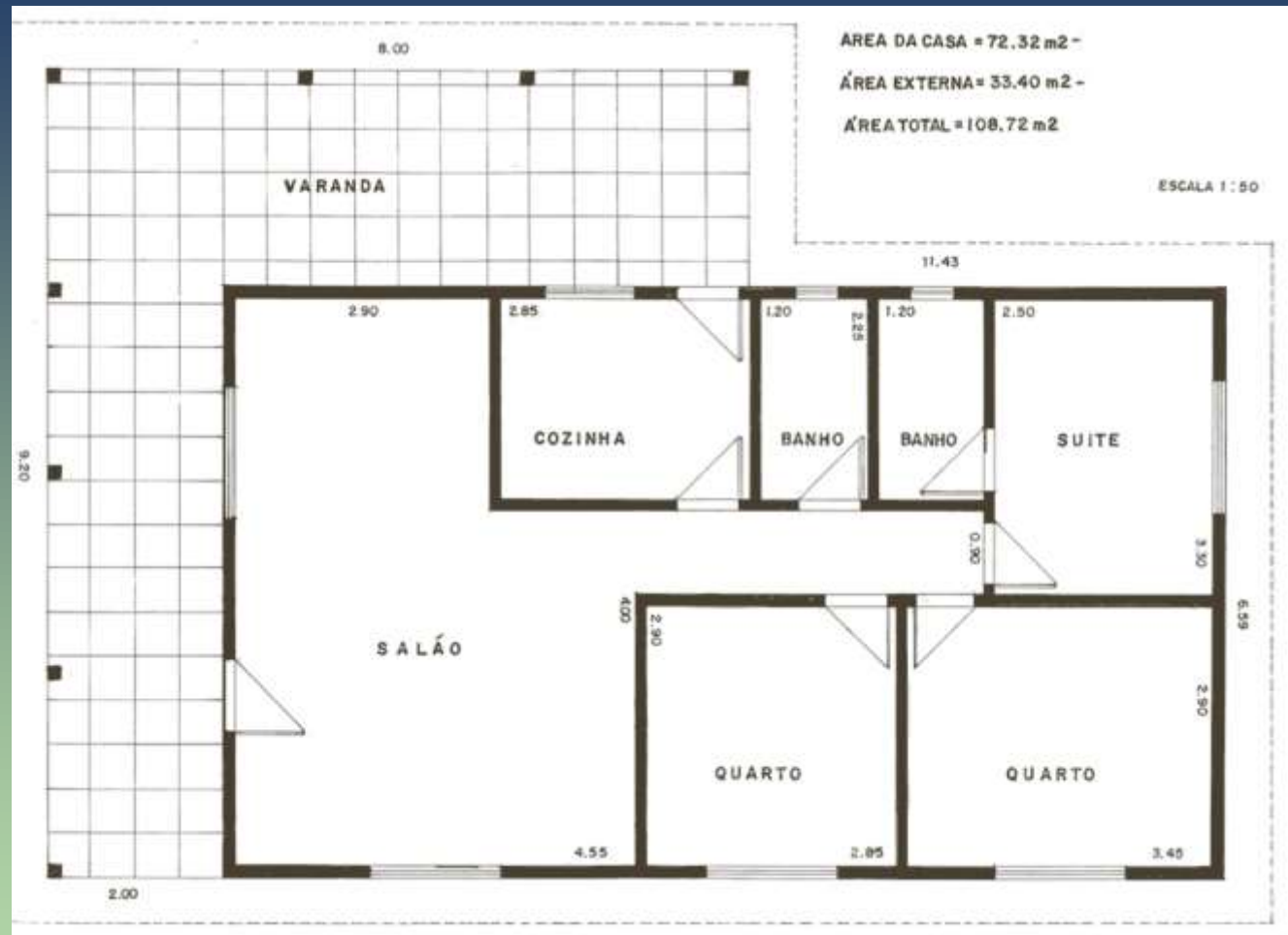

Planta baixa - Técnica



ÁREA DA CASA = 106,41 m² -
ÁREA EXTERNA = 43,50 m² -
ÁREA TOTAL = 149,91 m² -

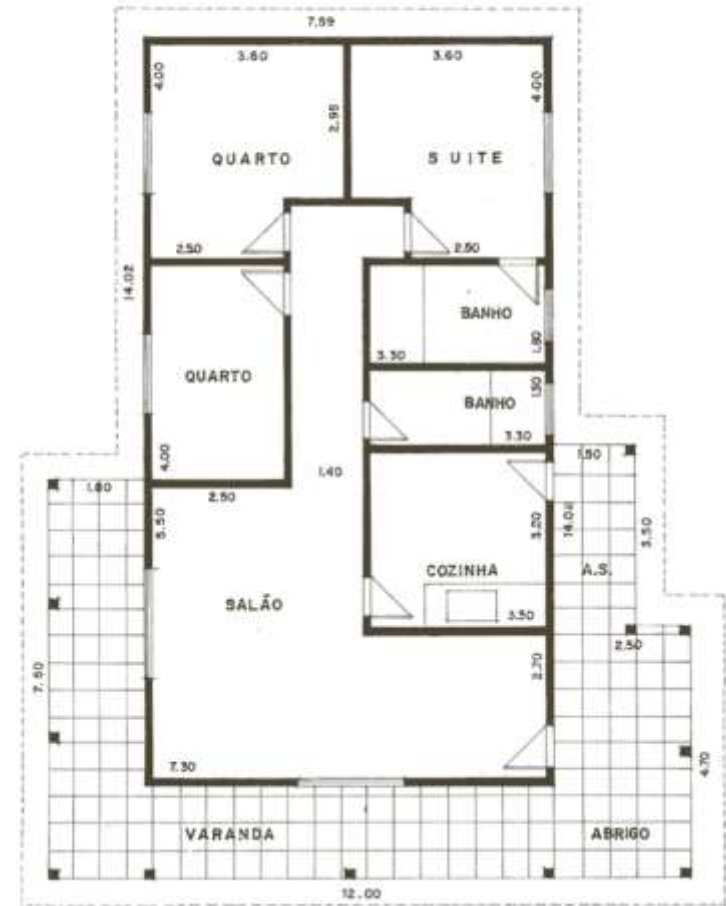

Planta baixa - Técnica

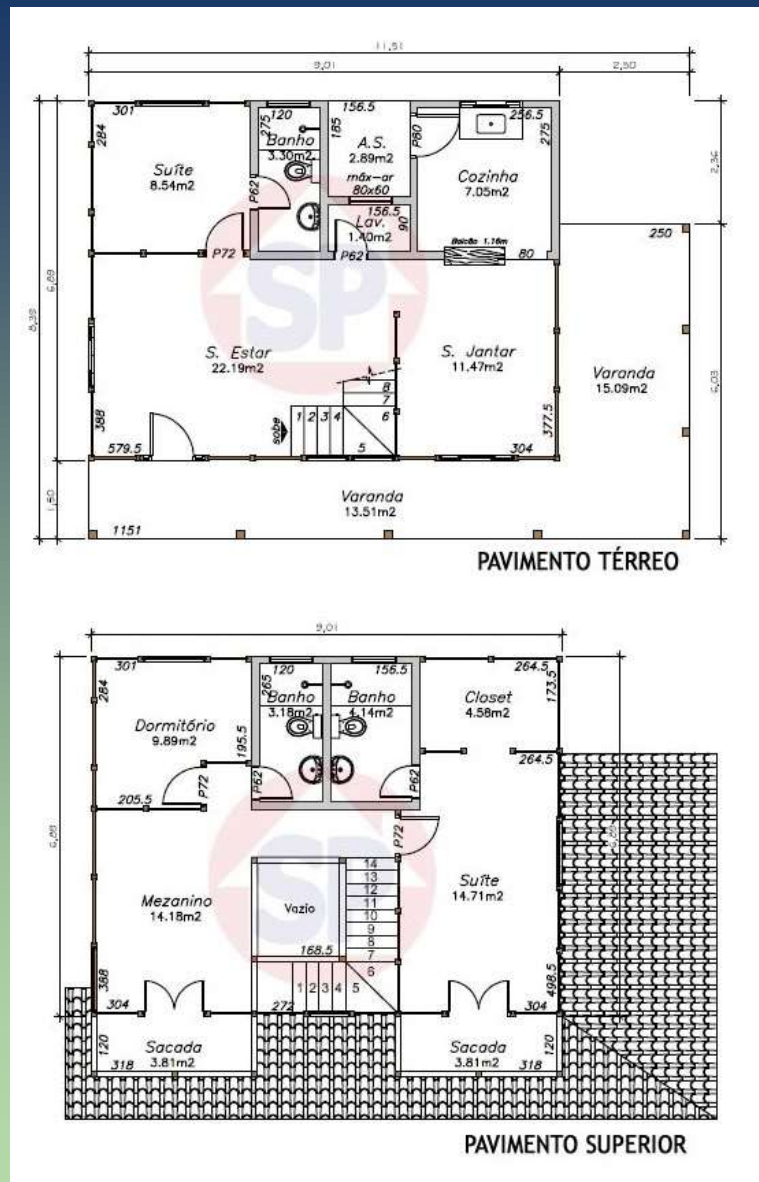

Planta baixa - Técnica

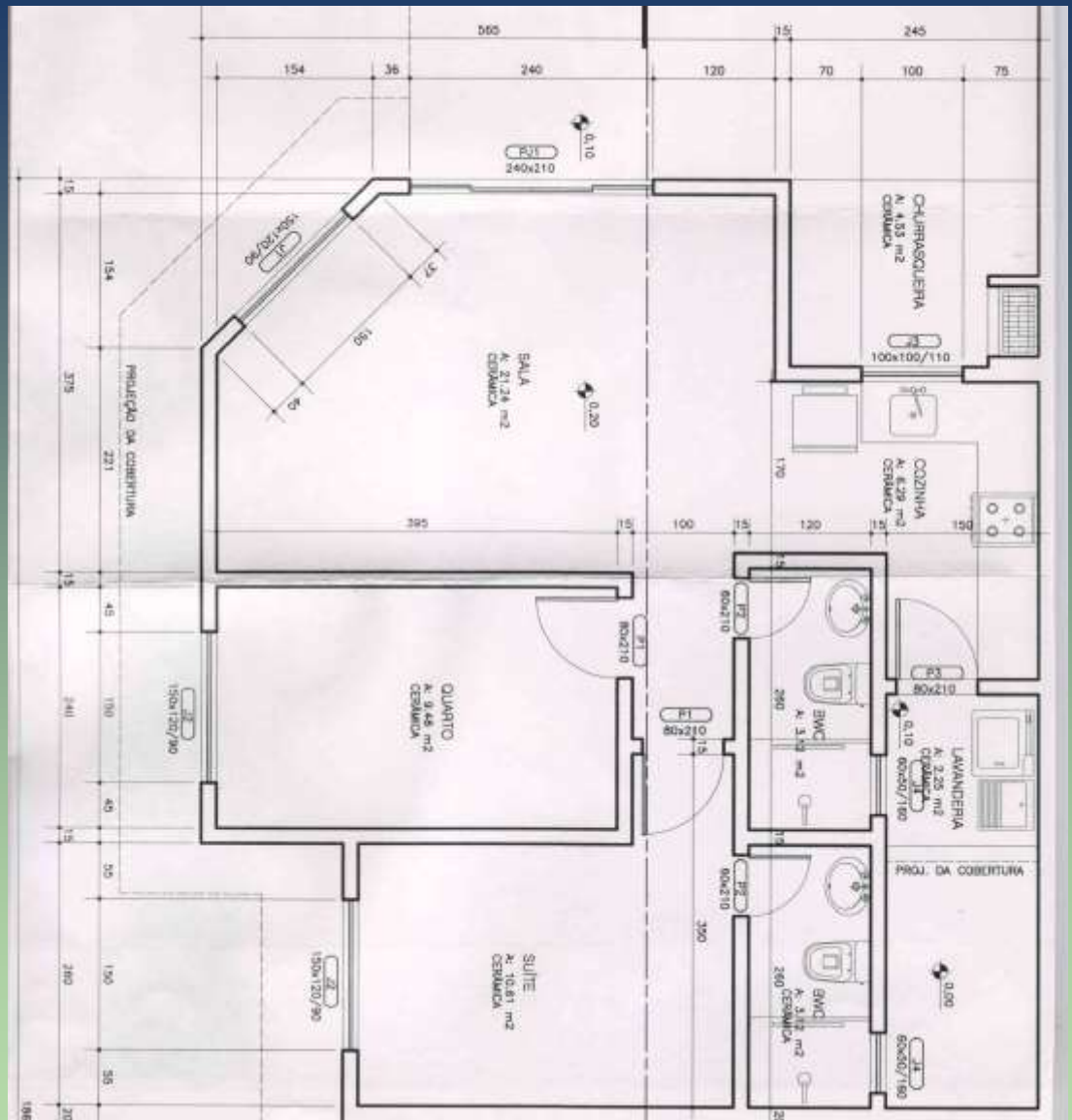

Planta baixa - Técnica



ÁREA DA CASA = 74.53m² - ÁREA EXTERNA = 35.43 m² - ÁREA TOTAL = 109.96 m²



ESC. 1:75

Planta baixa - Técnica

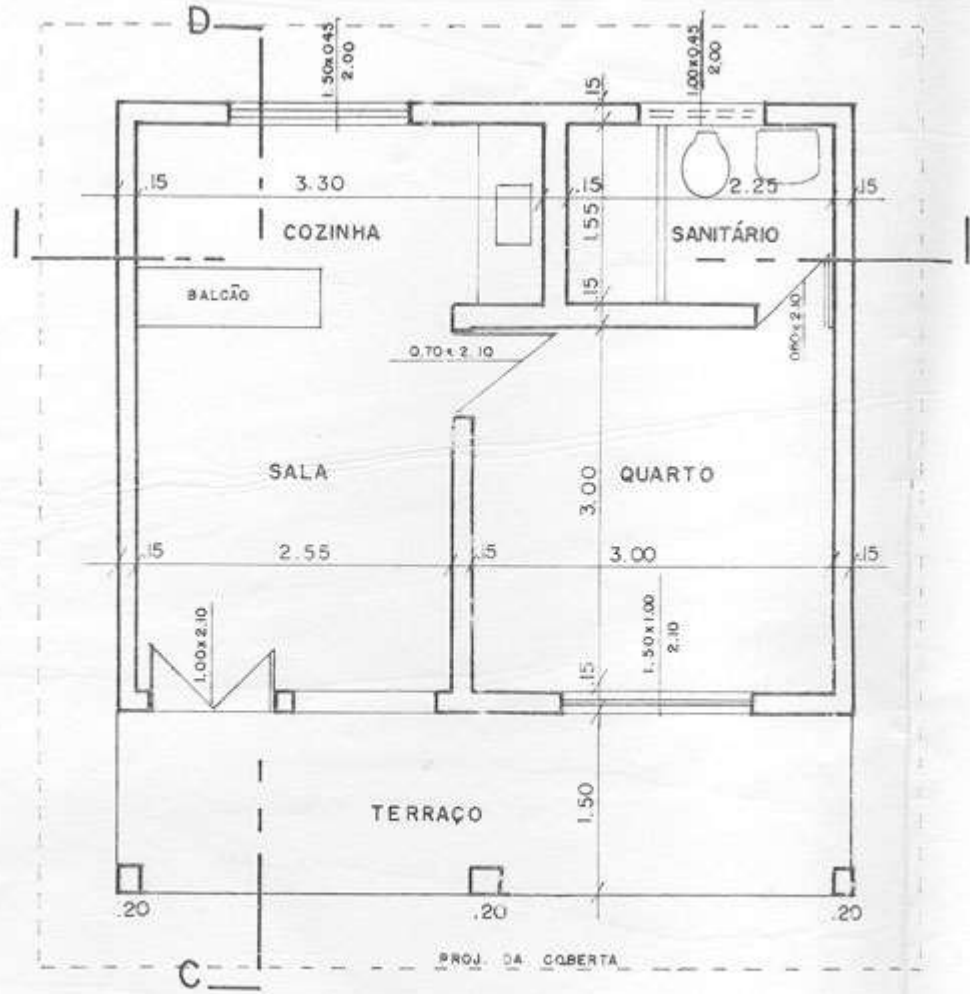

PLANTA BAIXA

ESCALA 1/50



Planta baixa - humanizada



Planta baixa - humanizada



RESIDENCIAL VILLA CREMONA

Local: Rua Maranhão, Esq. Rua Sergipe - Erechim / RS



Planta Meramente Ilustrativa - Os móveis não fazem parte do imóvel

CONSTRUÇÃO:



Av. Maurício Cardoso, 85 - CREA Nº 99487
Fone: (54)321-1488 / 322-3488
ERECIM - RS - E-mail: engbado@ciatalpha.com.br

INCORPORAÇÃO E VENDAS:



Av. Sete de Setembro, 255 - CRECI Nº 21908
Fone: (54)322-5874 / 322-2277
ERECIM - RS - E-mail: bademi@viva-ri.net

Planta baixa - humanizada



Planta baixa - humanizada



Planta baixa - humanizada



Residencial
Marcela



Planta baixa - humanizada

Apartamento de Cobertura - 2º Piso



Planta baixa - humanizada



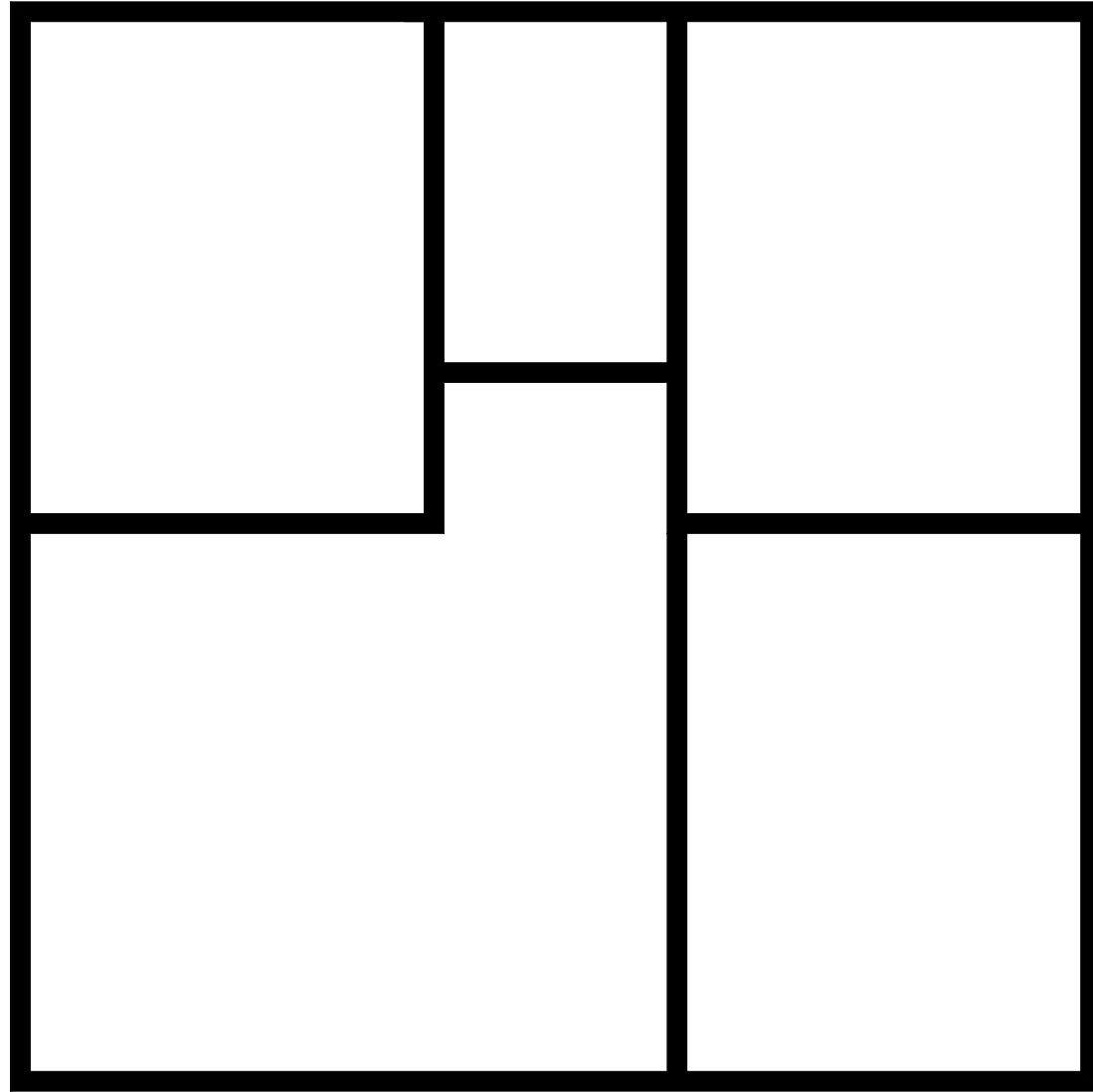

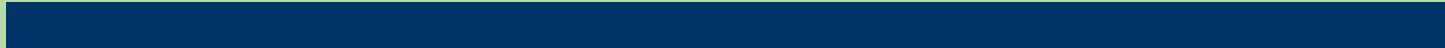
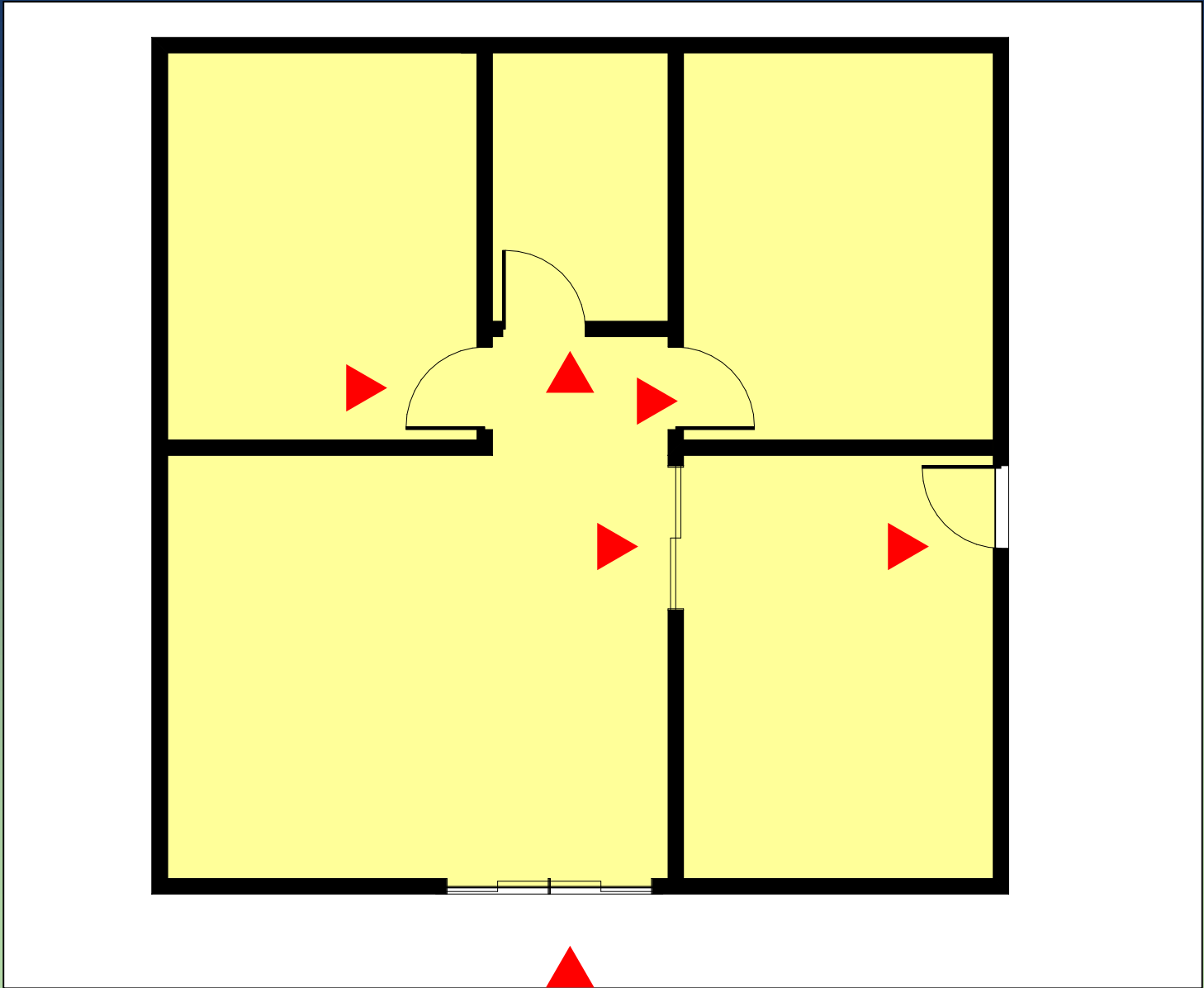

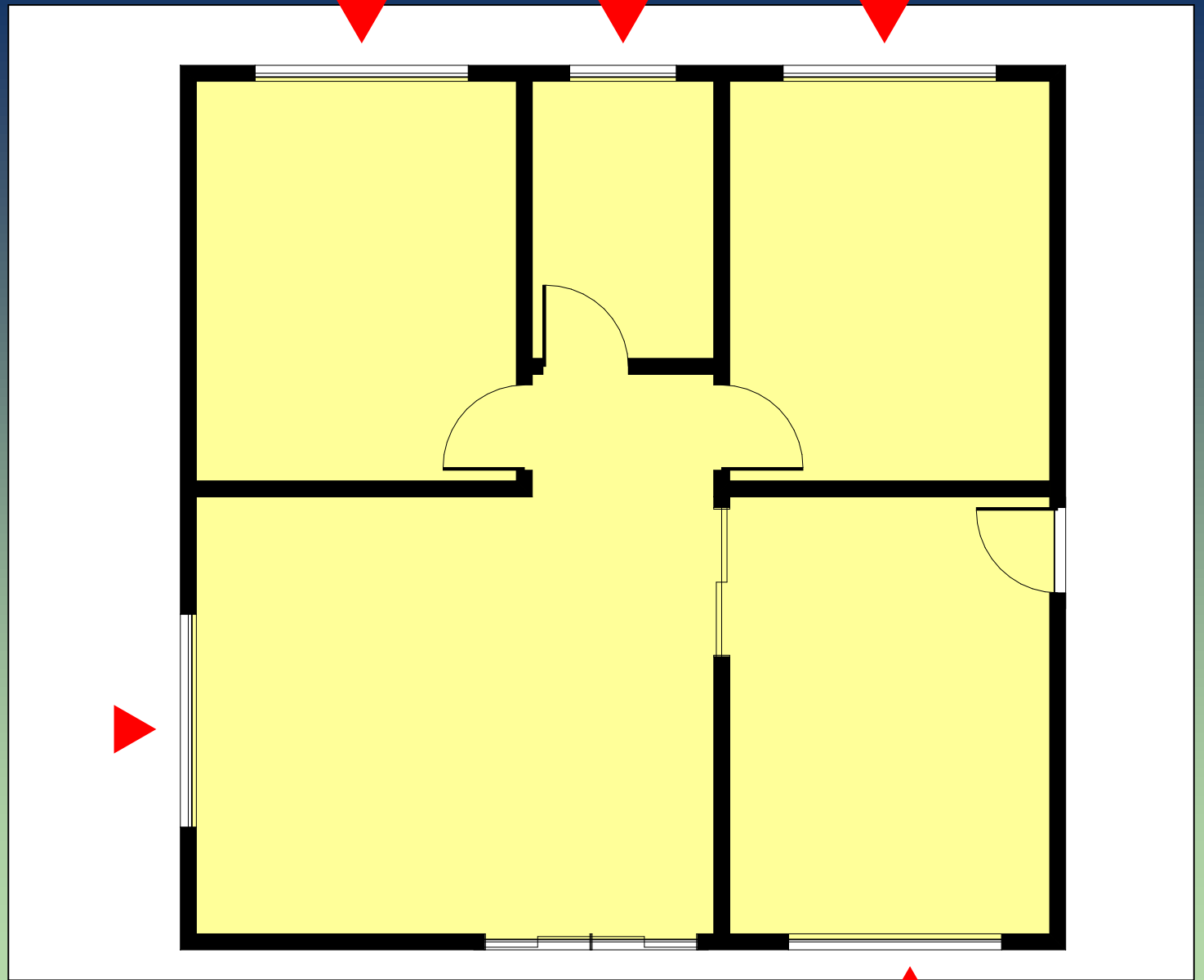

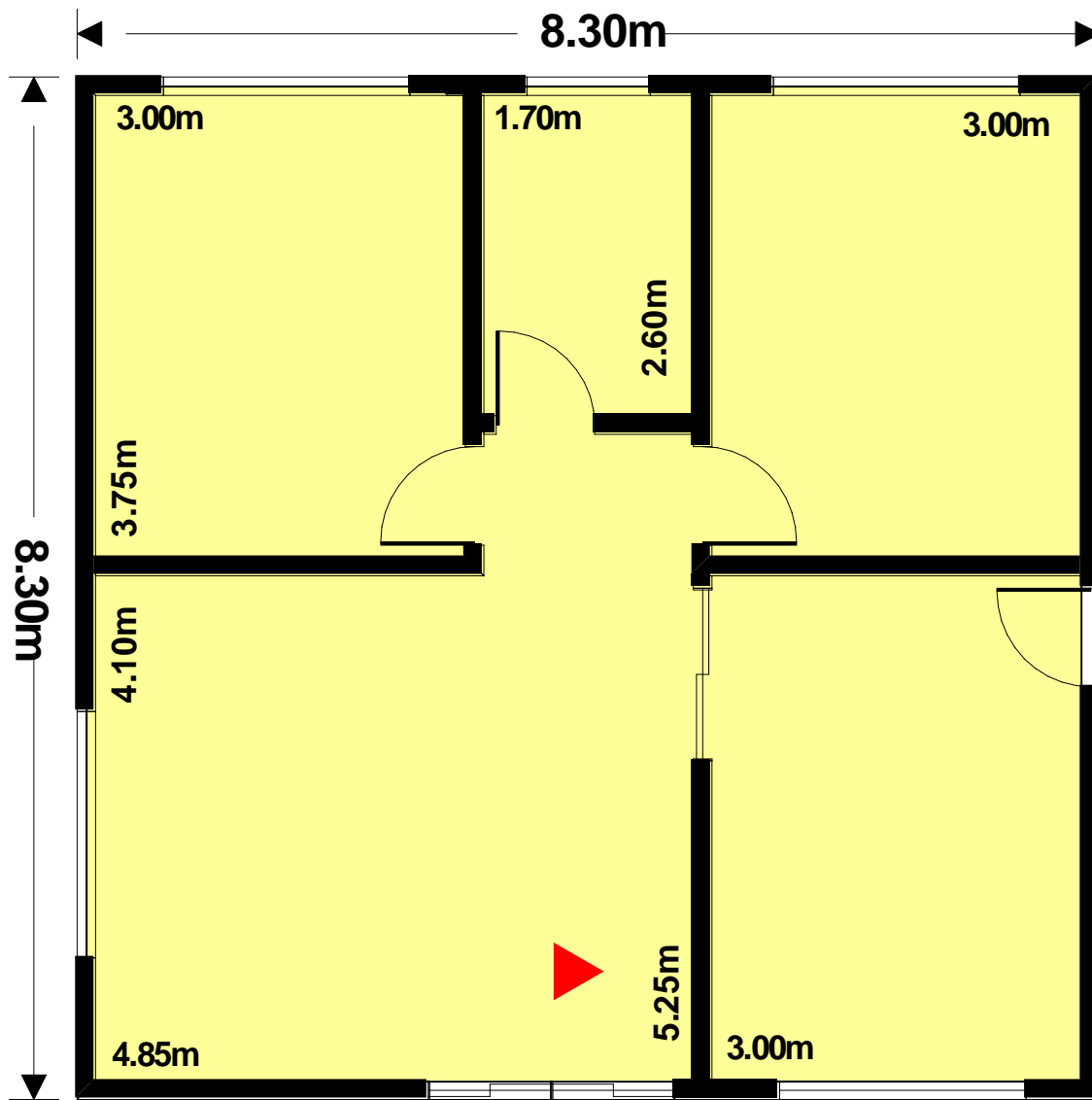

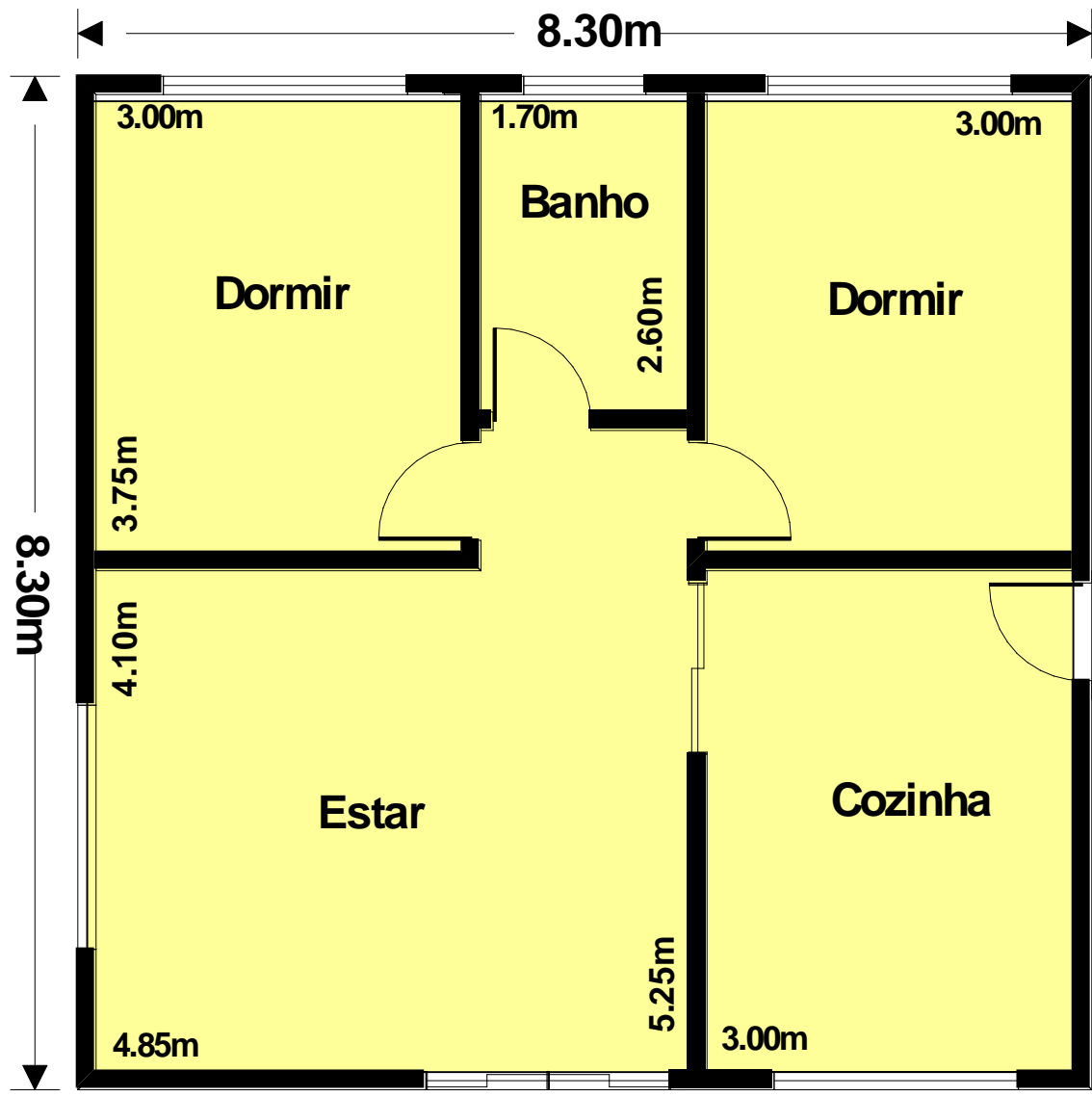

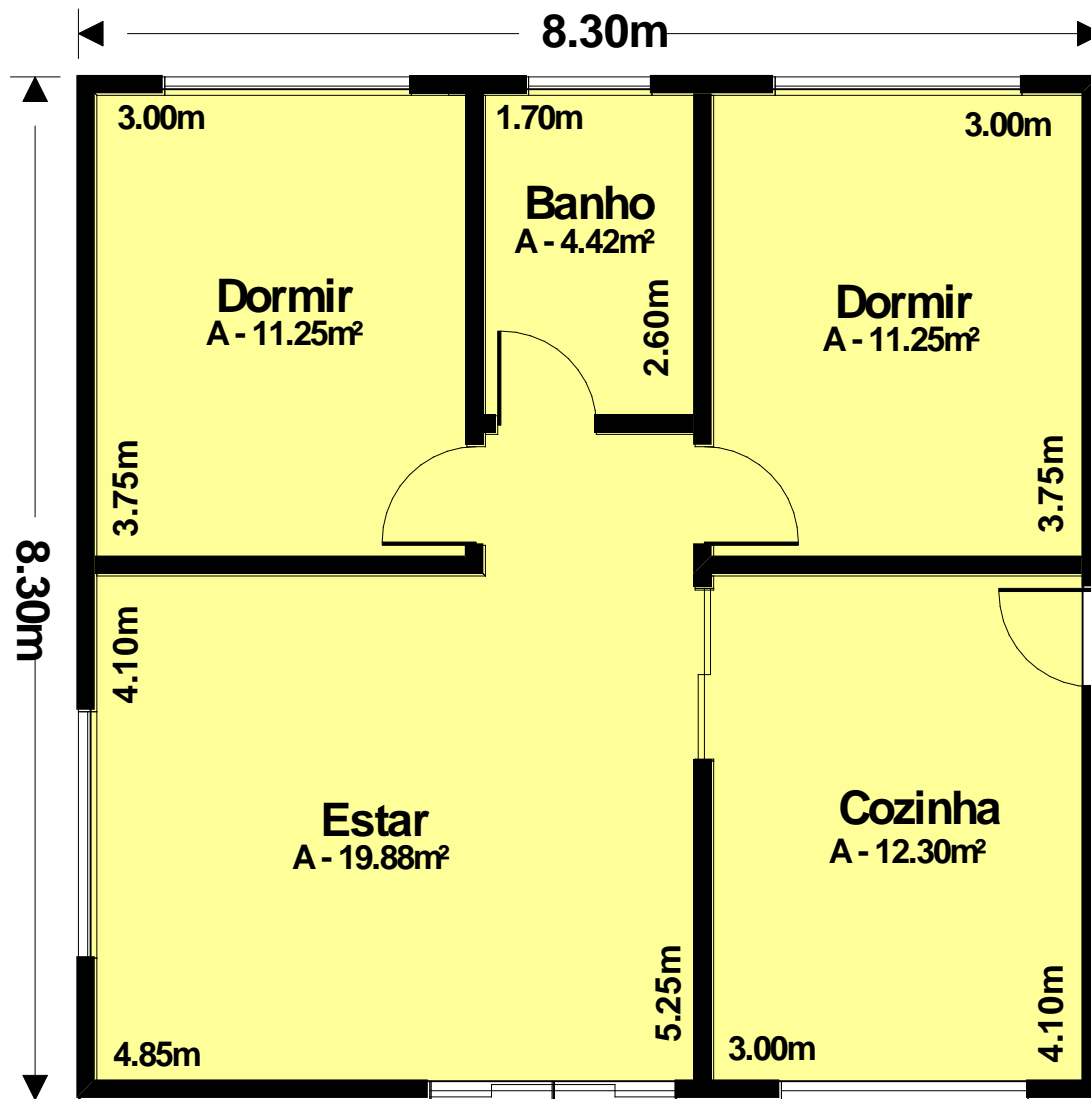

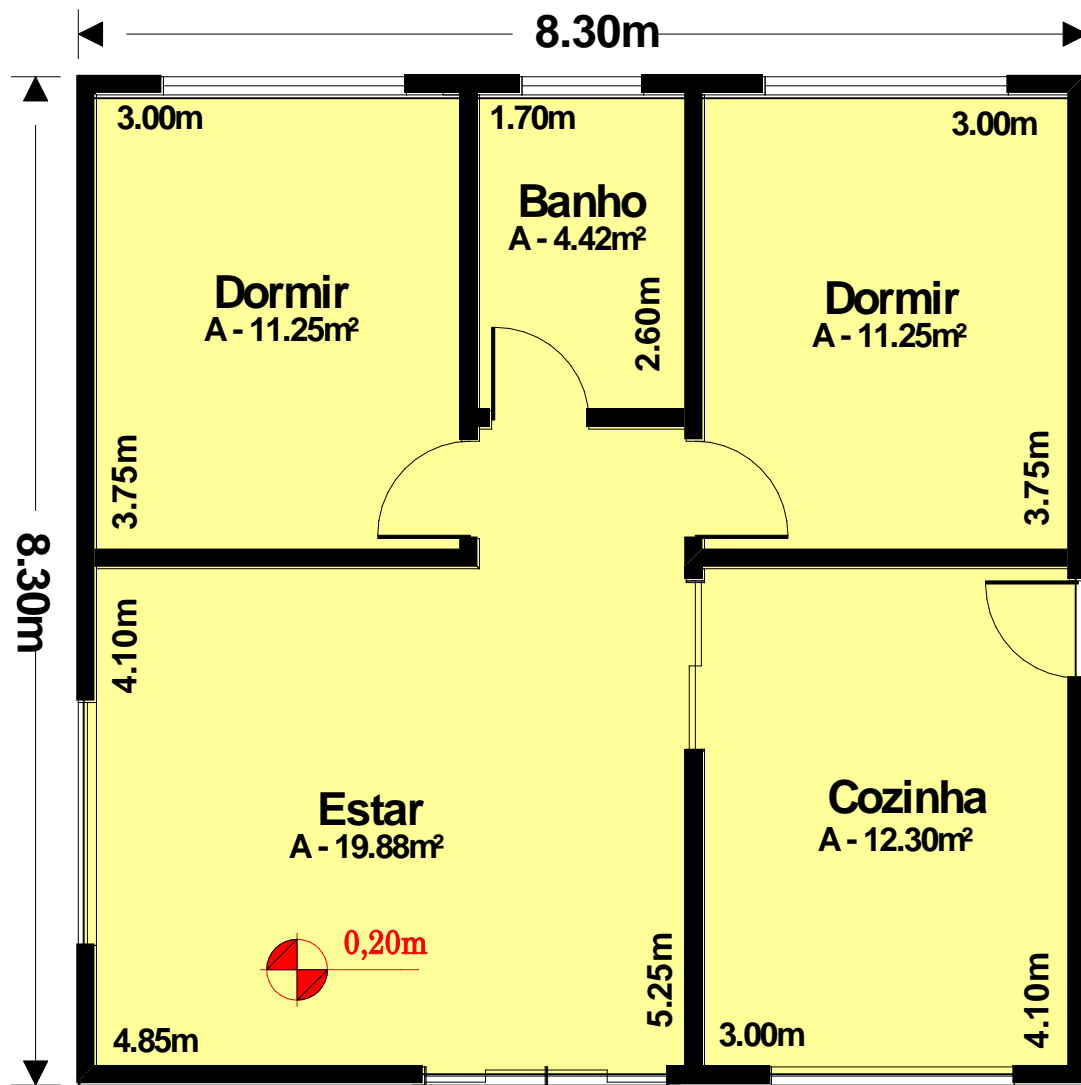

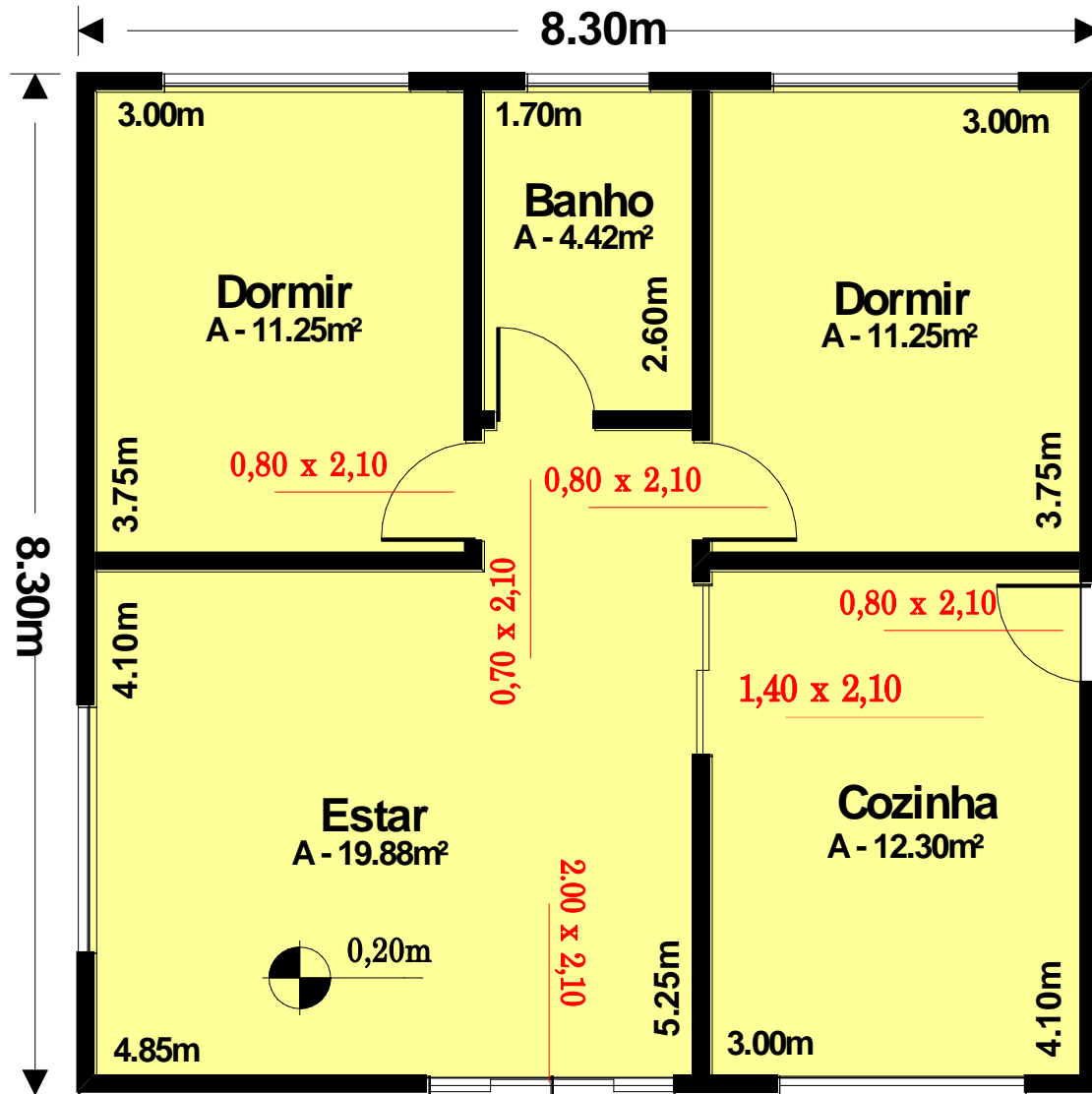

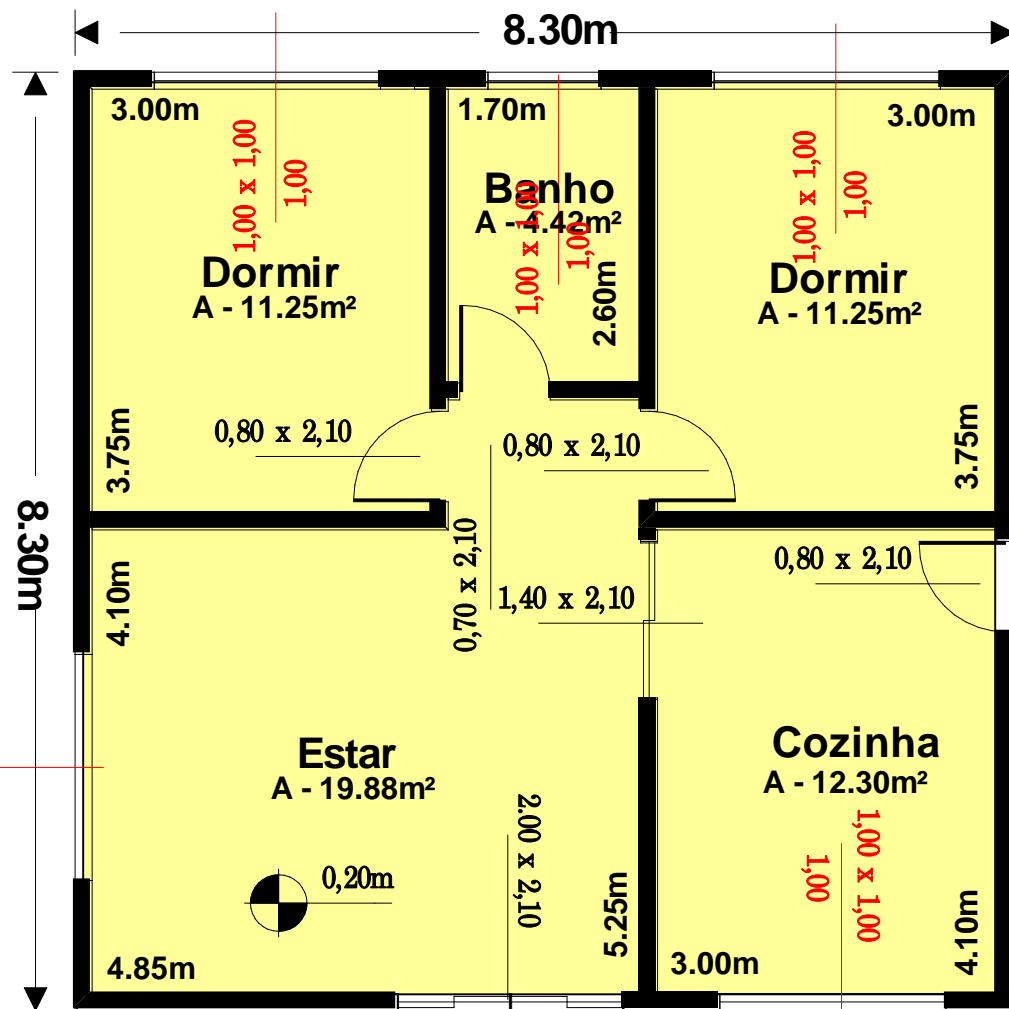

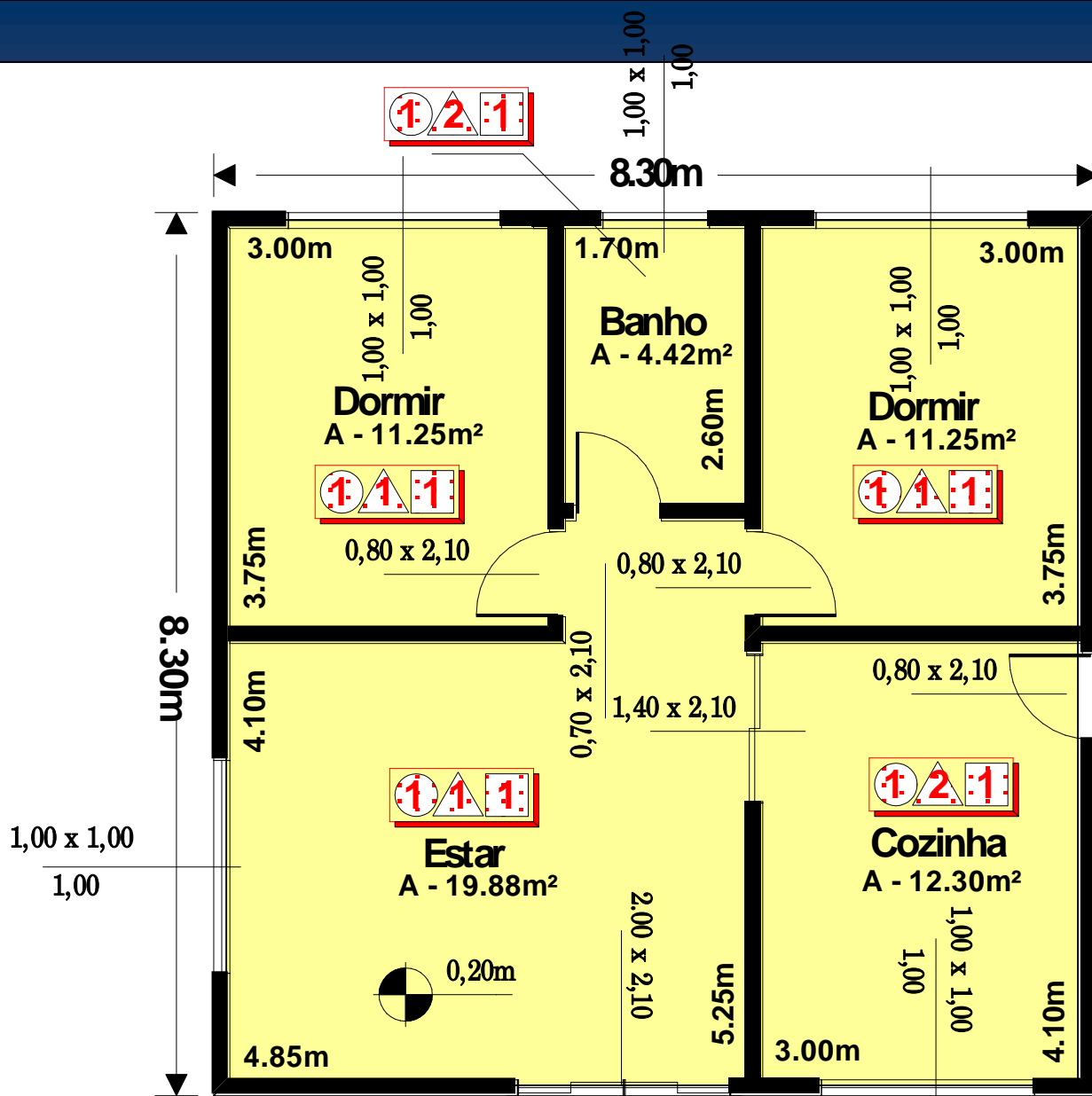

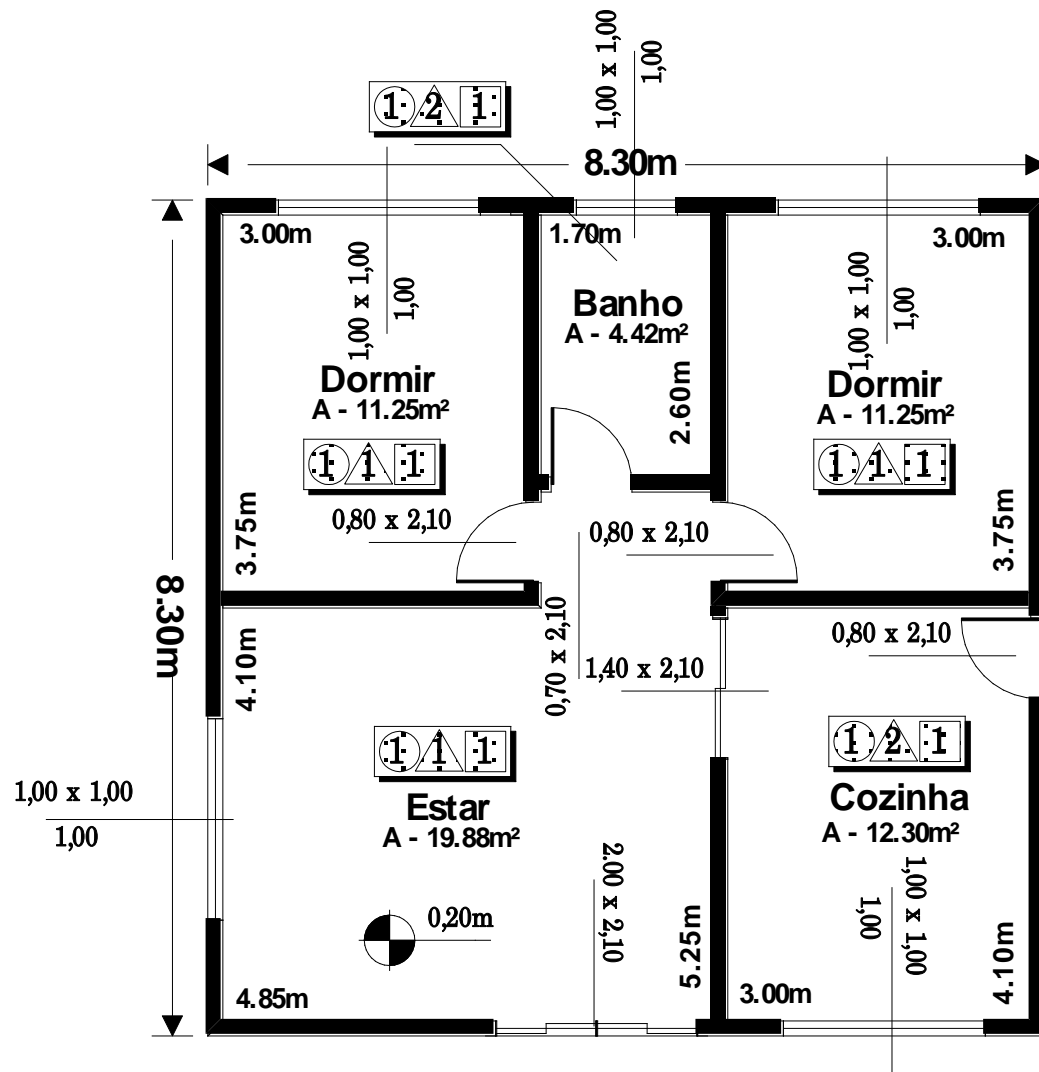

Planta

Escala - 1 / 100

